

FLUID HANDLING

Filter Cart

A portable, offline filtration system that's ideal for mineral-based industrial fluids and a wide range of applications.



Overview

The Filter Cart:

Where It's Used

- Decontaminating systems
- Flushing new or repaired systems
- Dispensing oil
- Pre-filtering new oil
- Evacuating used oil
- Topping off reservoirs
- Collecting oil samples for analysis

What Is Standard?

- Automatic pressure relief valve
- Dual-stage filtration
- 12' hose assemblies with various quick connect options
- Pneumatic wheels for easy mobility
- Industrial powder-coated paint
- Heavy-duty cart with oil catch pan
- One-year warranty

What Can I Customize?

- Flow rates
- Filter bypass
- Sample valves
- Y-strainer
- Connection sizes
- Color
- Hose-end connection sizes and types
- Micron rating of filters

Performance

For filtering mineral-based industrial oils and most synthetic oils with a maximum operating viscosity range of ISO VG 680 (3000ssu/648cSt) at 100°F/38°C within ambient temperature ranges of -15°F to 150°F (-26°C to 66°C)

Materials:

- Frame: Carbon steel
- Paint: Industrial powder coat
- Filter Heads: Aluminum
- Fittings: Zinc-plated steel and/or brass
- Pumps: Aluminum/steel
- Hoses: Clear PVC with steel wire or hydraulic hose
- Gaskets: Buna-N

Filter Indicators:

- Filter indicator pops at 22psid (1.55bar) as warning that filter elements need to be replaced

Pump Relief:

- Opens at 65psi

Weight:

- Approximately 100-150lbs (will vary depending on options selected)

Dimensions:

- 18.8"L x 21.5"W x 46.4"H

Call Des-Case for the Following Needs:

- CE certification
- Explosion-proof
- Wands
- Threaded end connectors
- Particle counters
- Hydraulic hoses
- Viton® gaskets
- High viscosity push button sample valves

Specifications

By the Numbers:

Item No.	Description	Qty.
1	Motor	1
2	Gear Pump	1
3	Filter Head	2
4	Pressure Gauge	1
5	Filter Element A	1
6	Filter Element B	1
7	Post-Filter Sample Valve	1
8	Pre-Filter Sample Valve	1
9	25' Cord	1
10	12' Suction Hose	1
11	12' Pressure Hose	1
12	Manual Filter Bypass Valve	1
13	Filter Bypass	1
14	Pump Relief-65psi	1
15	Filter Change Indicator	1

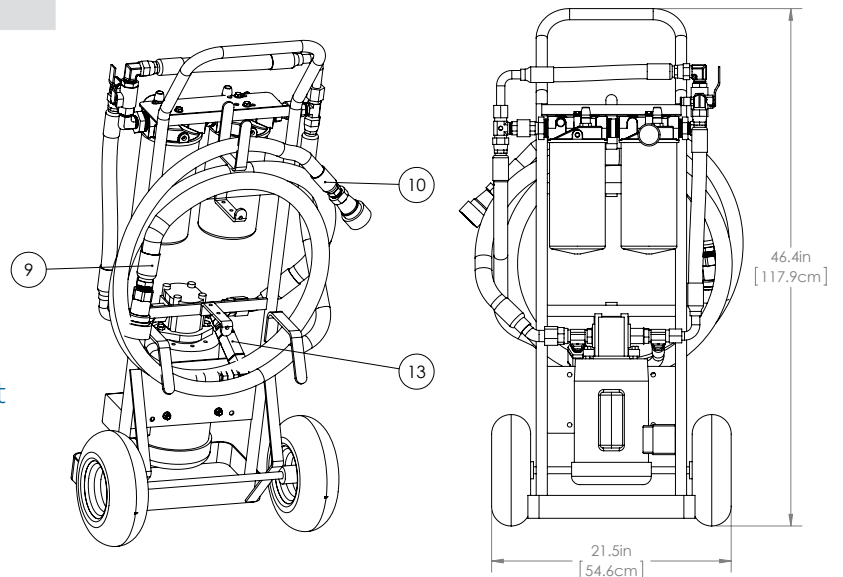
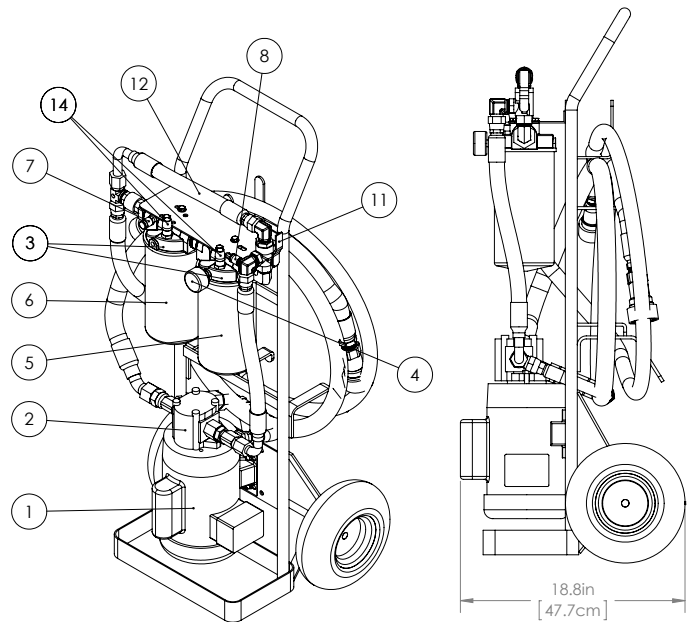

Did You Know?

The filter cart pairs perfectly with Des-Case's tote, drum, hydraulic, gearbox, and drain port adapter kits. Customize your mating kit at www.descase.com.

To Order: Filter Cart

FC										
	Box 1	Box 2	Box 3	Box 4	Box 5	Box 6	Box 7	Box 8	Box 9	Box 10

Pump/Motor Combinations [Box 1]

60 Hz Options		50 Hz Options	
Code	Description	Code	Description
02E	2gpm/1 hp electric, 115 vac, 60 Hz, 1725 rpms, 13 amps	02G	1.5gpm/1 hp electric, 110 vac, 50 Hz, 1425 rpms, 12.4 amps
05E	5gpm/1 hp electric, 115 vac, 60 Hz, 1725 rpms, 13 amps	05G	4gpm/1 hp electric, 110 vac, 50 Hz, 1425 rpms, 12.4 amps
10E	2gpm/1 hp electric, 115 vac, 60 Hz, 1725 rpms, 13 amps	10G	8gpm/1 hp electric, 110 vac, 50 Hz, 1425 rpms, 12.4 amps
02F	2gpm/1 hp electric, 230 vac, 60 Hz, 1725 rpms, 6.5 amps	02H	1.5gpm/1 hp electric, 220 vac, 50 Hz, 1425 rpms, 6.2 amps
05F	5gpm/1 hp electric, 230 vac, 60 Hz, 1725 rpms, 6.5 amps	05H	4gpm/1 hp electric, 220 vac, 50 Hz, 1425 rpms, 6.2 amps
10F	10gpm/1 hp electric, 230 vac, 60 Hz, 1725 rpms, 6.5 amps	10H	8gpm/1 hp electric, 220 vac, 50 Hz, 1425 rpms, 6.2 amps
Pneumatic Options		Pneumatic Options	
02A	2gpm/1.7 hp air, 0-3000 rpms	08A	8gpm/1.7 hp air, 0-3000 rpms

NOTE: Performance will vary depending on operating temperature, fluid type, and unit options. 65psi pressure relief valve included.

Drain & Fill Connector Type [Box 2]

Code	Description
B	ISO B Connector
A	ISO A Connector
F	Flush Face Connector
R	ISO B Connector-BSPP
Q	ISO A Connector-BSPP
P	Flush Face Connector-BSPP

NOTE: All connectors are coupler ends (female)

Filter A [Box 4]/Filter B [Box 5]

Code	Description
A	5-micron Particulate Filter
B	7-micron Particulate Filter
C	12-micron Particulate Filter
D	22-micron Particulate Filter
J	Water Filter

Drain & Fill Sizing [Box 3]

Code	Description
1	Drain: 1" hose & connection Fill: ¾" hose & connection
2	Drain: ¾" hose & connection Fill: ½" hose & connection

NOTE: Units are built for optimum performance when using 1" (drain) and ¾" (fill) connections. Decrease in performance may occur when selecting other size combinations. Hoses are 1" and ¾" respectively regardless of connection sizes.

Manual Filter Bypass [Box 6]

Code	Description
0	None
B	Filter Bypass

Sample Valves [Box 7]

Code	Description
0	None
1	Standard
2	High Viscosity

Options 8 through 10 continued on reverse

To Order: Filter Cart

Cord [Box 8]

Code	Description
0	None*
C	25' cord

*Comes with the standard cord or no cord for pneumatic/air systems

Y-Strainer [Box 9]

Code	Description
0	None
Y	Y-Strainer

Custom Colors [Box 10]

Code	Description
1	Brushed Aluminum
2	Black
3	White
4	Blue
5	Red
6	Yellow

Replace Your Elements

Part No.	Micron Rating
DC-S10000S08BBU	Beta 1000 @ 5um
DC-S10000S08CBU	Beta 1000 @ 7um
DC-S10000S08EBU	Beta 1000 @ 12um
DC-S10000S08FBU	Beta 1000 @ 22um
DC-S10000W08FBU	Water Removal

NOTE: Other micron sizes available upon request

You also can customize your system online at www.descase.com.